

See discussions, stats, and author profiles for this publication at: <https://www.researchgate.net/publication/284130981>

The Potential of Agrivoltaic Systems

Article in *Renewable and Sustainable Energy Reviews* · February 2016

DOI: 10.1016/j.rser.2015.10.024

CITATIONS

323

READS

12,726

2 authors, including:



Joshua M Pearce

The University of Western Ontario

601 PUBLICATIONS 21,260 CITATIONS

SEE PROFILE

Some of the authors of this publication are also working on these related projects:



Michigan Tech's Open and Sustainable Technology Lab [View project](#)



Plasmonic Enhanced Thin Film Solar Cells [View project](#)

The Potential of Agrivoltaic Systems

Harshavardhan Dinesh¹ and Joshua M. Pearce^{1,2,*}

1. Department of Electrical & Computer Engineering, Michigan Technological University
2. Department of Materials Science & Engineering, Michigan Technological University

* Contact author:

601 M&M Building
1400 Townsend Drive
Houghton, MI 49931-1295
906-487-1466
pearce@mtu.edu

Abstract:

In order to meet global energy demands with clean renewable energy such as with solar photovoltaic (PV) systems, large surface areas are needed because of the relatively diffuse nature of solar energy. Much of this demand can be matched with aggressive building integrated PV and rooftop PV, but the remainder can be met with land-based PV farms. Using large tracts of land for solar farms will increase competition for land resources as food production demand and energy demand are both growing and vie for the limited land resources. This land competition is exacerbated by the increasing population. These coupled land challenges can be ameliorated using the concept of agrivoltaics or co-developing the same area of land for both solar PV power as well as for conventional agriculture. In this paper, the agrivoltaic experiments to date are reviewed and summarized. A coupled simulation model is developed for both PV production (PVSyst) and agricultural production (Simulateur multIdisciplinaire les Cultures Standard (STICS) crop model), to gauge the technical potential of scaling agrivoltaic systems. The results showed that the value of solar generated electricity coupled to shade-tolerant crop production created an over 30% increase in economic value from farms deploying agrivoltaic systems instead of conventional agriculture. Utilizing shade tolerant crops enables crop yield losses to be minimized and thus maintain crop price stability. In addition, this dual use of agricultural land can have a significant effect on national PV production. The results showed an increase in PV power between over 40 and 70GW if lettuce cultivation alone is converted to agrivoltaic systems in the U.S. It is clear, further work is warranted in this area and that the outputs for different crops and geographic areas should be explored to ascertain the potential of agrivoltaic farming throughout the globe.

Keywords : agrivoltaic; agriculture; photovoltaic; farming; joint production; land equivalent ratio; solar farm; economics; photovoltaic; large scale

1. Introduction

Both the continued depletion of fossil fuel resources [1] and the detrimental effects of burning them for energy such as climate change [2-4] has put an onus on decarbonization [5] by switching to

renewable and clean sources [6-9] of energy such as solar power [10]. There has been significant progress in solar photovoltaic (PV) technology to utilize the vast, clean and sustainable source of energy to satisfy humanity's energy demands [11-12]. The IEA predicts approximately 6000 TWh of PV power will be generated in 2050 to supply society's needs, which would be around 16% of the total energy generated [13]. To meet that predication and provide the concomitant greater portion of total global demand with PV, large surface areas are needed because of the relatively diffuse nature of solar energy. Much of this demand can be met with aggressive building integrated PV (BIPV) and rooftop PV [14-17], and the remainder can be met with land-based PV farms [18-21]. Using large tracts of land for solar farms will increase competition for land resources as food production demand and energy demand are both growing and vie for the limited land resources [22-24]. This land competition becomes particularly acute in densely populated regions, mountainous areas, and small inhabited islands and is further fueled by the increasing population of 1.15% per year [25]. These coupled land challenges can be ameliorated using the concept of agrivoltaics or co-developing the same area of land for both a solar PV power station as well as for conventional agriculture.

This paper first reviews the theoretical and experimental work on agrivoltaics and analyzes the potential crop yields and solar power output as a function of the incoming solar radiation. For fixed tilt agrivoltaic farms, the optimal tilt angle of the PV is normally determined with an objective of maximizing solar power output and the pitch is determined by the spacing requirements of a given type of crop harvesting. As the PV create some shading on the crops planted between the rows, the sensitivity of the crop yield with respect to the shading effect is examined. The PV power output and crop yields are compared against that of an optimized PV power station and crop yields of conventional large-scale monocrop farms. A sensitivity analysis is performed based on the review of agrivoltaic research using the potential economic value of agrivoltaic farms to determine viability and for guiding future dual use farms.

2. Background

The precursor to the agrivoltaic system was the agroforestry system, which involved intercropping between crops and trees [26]. In the past the solution for the issue of competition for land resources between food and energy production has been addressed by the division of a piece of land for food and energy production [27]. Now following the example of agroforestry, it is possible to combine food and energy production on the same piece of land [28]. This is now known as agrivoltaics and was conceptualized as a solution to the increasing land competition between food and energy production [22]. Although agrivoltaics have been theorized in the early 1980s using the space between PV rows for crops (Figure 1A), the first detailed agrivoltaic farm experiments were only recently performed in Montpellier, France in 2013 [29,30]. This system consisted of stilt mounted PV modules which were 0.8m wide, mounted at a height of 4m and tilted at an angle of 25° [29,30]. A rough schematic of this setup is shown in Figure 1B. Lettuce crops were grown beneath the stilts and the lettuce yields and the behavior of the lettuce crop under shading were analyzed. The results have shown that shading for this crop has no significant effect on the yield due to the adaptive capabilities of lettuce to adjust to the shading caused by the PV arrays. Thus, the same area of land was used to produce both, electricity and food successfully.

Dupraz et al. were then able to prove that the yields from the agrivoltaic farm experiment were higher than their respective monosystem equivalent with the use of the LER methodology [31].

LER is used to measure the efficacy of the agrivoltaic system when compared against a monocrop system [31]. Similarly, the LER for the PV output is obtained by comparing the power output of the agrivoltaic system against a standard PV farm. The LER for the solar power output is obtained by taking the ratio of the agrivoltaic system PV output and that of a regular PV farm. One of the primary factors that influence the output of both the PV modules and crop yield is shading, which is not necessarily always negative effect on the latter (as will be discussed below). In addition to shading, the crop output also depends on the photosynthesis process of the crops in converting the incoming solar radiation into biomass [32]. It is difficult to predict the manner in which each plant behaves under shading [33] as shade tolerance of plant depends on the type of foliage and there appears to be correlation between the leaf structure and plant tolerance to environmental conditions [34]. For example, lettuce can adapt itself to shading by increasing its leaf area to maximize its ability to tap the reduced solar radiation levels without significantly affecting yields [30], whereas, shading causes a reduction in wheat yields as it cannot adapt to the reduced light conditions [35]. Experiments conducted on the Paulownia variety wheat grown under shade showed a reduction in wheat yield by 51% [35]. Some of the experimentally verified shade tolerant crops are less common in conventional mass agriculture such as hog peanut, alfalfa [36] yam, taro, cassava and sweet potato [37].

In an agrivoltaic system, the solar power output is maximized by optimizing the tilt angle to tap maximum solar radiation. The tilt angle, Θ , is shown in Figure 1. The optimal tilt angle for the PV modules is normally based on the annual local solar irradiation [38]. Inter-row shading of the PV modules should be minimized, which is generally not a problem in agrivoltaics as the inter-row spacing (x in Figure 1) tends to be larger than a conventional solar farm. The output of the PV module also depends on the operating temperature of a PV module, which is dependent on the ambient temperature, wind speed and solar radiation [39]. The crops in an agrivoltaic setup may improve the temperature of the PV array, but no data is available at the time of this writing to verify that potential. On the other hand, the growth of plants between PV rows can have a negative effect due to dust generation from farming as dust collection on the PV modules decreases the electricity output. The amount of dust collected on the surface of the PV module decreases as the tilt angle increases [40].

Ex-ante simulations performed by Dupraz et al. on an agrivoltaic systems have shown an increased land productivity in the range of 60-70% [31]. The micro-climate conditions in the vicinity of the PV modules and its effect on the crops were studied and it was observed that air temperature and vapor pressure density were unaffected in case of a stilt mounted agrivoltaic system, while PV panels reduce soil temperature and affect the incoming solar flux distribution [30]. The LERs show that the yields from an agrivoltaic system are higher than their respective mono-system yield (solar power and crop yields) [31]. Taking into account the response of the crop yields with respect to changes in climate and its effect on the crop's genetic traits, a model was proposed which showed that the crop relative yield could be factorized into terms that show the effect of the cropping processes on the crop yield [40]. The agricultural wastes from the crops can also be used to produce biofuels, which is used for powering cars, heating systems and also to produce electricity, thus increasing the output of the agrivoltaic system further [41].

An agrivoltaic system can also be formed with a greenhouse by placing PV on the side of the greenhouse roof, which is useful in places such as islands where there are limited land resources [42]. By covering half of the greenhouse roof area with PV modules, it was observed that there was a reduction of 64% in the total available annual solar radiation and the area directly under the shade of the PV modules faced an 82% reduction in annual solar irradiation; and as this shading inhibits growth

in the crops and causes losses on account of lower crop weight and growth inhibition [43].

However, incorporating PV into agriculture can also be beneficial for crops. The shading caused by the PV modules helps in alleviating water evaporation during the summers and proves beneficial especially in the dry season. It was observed that shading resulted in water savings in the range of 14-29% depending on the level of shade [50]. This benefit could be of significant use in areas experiencing severe droughts, exacerbated by climate change. PV modules have also been shown to alleviate soil erosion by reducing the moisture evaporation [44]. In addition, an agrivoltaic farm can act as a standalone power source for powering irrigation and pumping schemes in locations having electricity shortage or non-existent grid supply, thus ensuring food security [45].

Finally, an agrivoltaic solution can also be offered as a solution to the resentment against conversion of arable farmlands into PV farms due to policies which favor PV farms causing a reduction in food production [46].

3. Methods

Using the existing literature summarized in Section 2 a generalizable solar PV model for agrivoltaic systems is created and then coupled with a crop model and solar radiation model to quantify the performance of agrivoltaic systems. The performance of the PV is a function of the incoming solar irradiation for the PV modules. Likewise, the crop yields depends upon the radiation conversion efficiency which gives the efficiency of the process of converting the photosynthetically active radiation (PAR), which is between 400-700nm (3.1-1.77 eV), into dry matter.

3.1 Solar PV system model

The solar PV modules can be either mounted on the ground (or near the ground) with the space between rows of modules used for agriculture and being large enough to accommodate farming equipment as shown in Figure 1 or be mounted on stilts with the area underneath the stilts used for agriculture as shown in Figure 2. In Figure 1 and 2, X is the distance [m] between PV module rows used for agriculture, Y is the horizontal projection of the PV [m], Θ is the tilt angle in degrees and z is the height [m] of the stilts.

As can be seen in Figure 2, all the land below the stilts is used for agriculture. The height of the stilts and spacing from adjacent stilts is such that standard farming equipment can pass below the stilts to harvest the crop without affecting the PV modules. This configuration ensures better land use as compared to the ground mounted PV modules as the land underneath the modules in the latter cannot be utilized. Although, obviously the increased land use efficiency comes with a higher cost in racking.

The crop selection, mounting height, optimal tilt angle, solar irradiation and local climate play a role in the optimal selection of PV system geometry for an agrivoltaic system. The configuration for the PV is determined by formulating an optimization problem with the objective of maximizing the solar irradiation incident on the PV which in turn is proportional to the power output of the PV module while taking into account the additional land cost from minimizing inter-row shading. The effect of this variance is included in the objective function on the optimization problem [38]. To compensate for shading and its effect on crop yields, the PV density can be reduced [31] or by the use of semi-transparent panels having a radiation transmission rate of 50% or more [47].

The sensitivity for the PV system output per unit area was modeled in PVSyst (version 6.34) with respect to the tilt angle, conversion efficiency and the row spacing of modules. A case study is evaluated for agrivoltaic grid-connected farm located in Kansas City (Lat:39.0997° Long:94.5783° Alt:

311m).

3.2 Crop Model

The Simulateur multIdisciplinaire les Cultures Standard. (STICS) crop model is used to obtain crop yield data for various types of crops as the model uses generic parameters, which are applicable to most crops [48]. STICS is a time step model which provides crop yields for various environmental conditions [48]. The STICS model consists of four main modules that pertain to the growth of the plant, interaction of the soil with the plants, the crop management module dealing with the farming techniques applied to the crops and the micro climate model which enumerates the effects of climate and soil water content on the climate surrounding the immediate vicinity of the crops. The type of crop being grown on the agrivoltaic farm can be classified as shade tolerant or shade intolerant depending on their ability to withstand low light levels.

3.3. The Combined Model and Case Study

A sensitivity analysis is performed to explore the behavior of lettuce, a shade tolerant crop, when planted between rows of ground mounted PV modules and when planted underneath stilt mounted PV modules to ascertain the yields in both configurations due to the variation in the levels of shading. The sensitivity of the lettuce yield per hectare with respect to changes in the level of shading and the harvest during the time of the year will be examined.

The optimal mounting configuration for the PV modules is obtained from the simulation based on the local solar irradiation data. Trinia Solar TSM300-P14A PV modules were used for simulation. The shading on the PV module varies according to the time of the year and height of the crops planted between the module rows. The PV power output by the different PV module configurations of stilt mounted (Figure 2) and ground mounted (Figure 1) were simulated. The ground mounted configuration of the agrivoltaic farm consisted of PV arrays mounted 1m above ground with a spacing of 6m. The spacing between the PV modules has been chosen such that industrial size harvesters and standard farming equipment can pass through between the PV module rows while maintaining a safe distance from the PV arrays. For the ground mounted configuration, the PV arrays have a dimension of 20m x 1m and the dimension for the farm between the modules are 20m x 5m. The stilt mounted agrivoltaic farm simulated had two sub-configurations; half density (HD) and full density (FD). In both the configurations, the PV modules are mounted at a height of 4m above the ground. In the HD configuration, there are two PV module arrays of 20m x 1m spaced 6.4m apart while in the FD configuration, there are four PV module arrays spaced 3.2m apart.

Both the stilt mounted configurations impart shading on the crop below. Lettuce is good crop for such an agrivoltaic system as it can withstand shading up to 30% [30]. Lettuce has a growth period of 6-8 weeks and grows up to a height of 6-12 inches and is generally grown in the late spring or early fall periods as the crop thrives in cool climates. The weights used for the simulation was experimentally determined for individual lettuce plant was 561gms for a summer harvest and 312g for a spring crop in clear sunshine [30]. For lettuce, STICS provides the yield per hectare of the aerial biomass, which is the combined weight of the crop heads per hectare.

4. Results

4.1 Performance of the PV Sub-system

The Kansans City PV system was simulated and the results showed that a fixed optimal tilt angle of 25° maximized PV output. At this tilt angle, the shading loss for the ground mounted configuration was 0.6% and for the FD stilt mounted configuration was 1.3%. The annual kWh output total and as a function of month of the PV modules for different configurations is shown in Tables 1, 2 and 3 for the ground mounted, full density and half density configurations respectively.

A sensitivity analysis was performed on the tilt angle and row spacing. The variation of the tilt angle is shown in Figure 3 for the ground mounted, stilt mounted FD and HD farms. P_{tilt} is the power output at a given tilt angle and P_{optimal} is the optimal tilt angle. As can be seen in Figure 3, the power output is affected more by the tilt angle in the FD configuration due to a lower spacing distance between the PV panel rows.

To gauge the sensitivity of the PV output with respect to changes in row spacing, a second ground mounted agrivoltaic farm was simulated having a spacing of 4m between the panels and the power outputs of this new farm were compared against the ground mounted, FD and HD agrivoltaic farm. In addition, a conventional industrial/utility scale solar PV farm is simulated to compare the power outputs with that of the agrivoltaic farm to determine the effectiveness of the agrivoltaic setup. The scale solar PV farm has the same dimensions as that of the agrivoltaic PV array, but has a spacing of 3m between the rows of modules. The mounting of the PV arrays is the same as that of the agrivoltaic setup and the shading effect caused by the modules have also been taken into account. The regular PV farm has PV arrays having dimensions of 20m x 1m tilted at 25° with a spacing of 1.25m. Such systems suffer from greater shading losses than an agrivoltaic setup, but more than make up for the loss with increased power density. The overall efficiency of the system is 11.96% compared to the roughly 1% higher efficiencies from the agrivoltaic systems with less row to row shading. However, as can be seen in Figure 4, conventional solar PV farms produce roughly double the electricity output per unit area of ground than even the full density agrivoltaic setup. The annual energy per unit area output of the new farm is shown in Figure 4. The sensitivity in this case is the change in the kWh/m² of different agrivoltaic farm configurations with respect to the spacing between PV module rows. The HD configuration is aimed at improving the available sunlight for the crops plant underneath the PV modules [30] and clearly has a reduced PV output compared to optimized farms and even modest spacing.

4.2 Crop Model

The growth of lettuce between the PV modules was simulated with STICS, which provided the number of lettuce plants per m² and weight of an individual plant for a lettuce crop grown under standard temperature and soil conditions. The crop yields (Y) in tons per hectare are calculated by:

$$Y [\text{Tons/Ha}] = (W \times d)/100 \quad (1)$$

where W is the fresh weight of lettuce plant (g) and d is the plant density per square meter. In Simulation of the ground mounted agrivoltaic farm on STICS resulted in a plant density of 9 per m² and the individual weight of each lettuce plant is 557 g. With this setup it was observed that for lettuce grown in the summer there was a 42% reduction in yields in FD and 19% at HD with respect to the weight of lettuce grown under clear sky conditions. It was also observed that for lettuce grown in the spring there was no significant effect on the lettuce yields in HD and a 21% reduction in yields for FD which is significantly more for a summer grown crop. This was due to the moderate shading conditions

during the spring planting. The moderate shading conditions during spring combined with the adaptive ability of lettuce and the HD configuration resulted in yields remaining significantly unaffected. The crop yields for the various agrivoltaic farms simulated are summarized in Table 4.

The crop model sensitivity depends on the shading as it affects the amount of incident solar irradiation intercepted by the crops which in turn affects the yield, which depends on the number of grains/heads per sq.m and the weight of each individual grain/head. As a result, the sensitivity for the crop model can be now described as the change in number and weight of grains/heads with respect to the shading as shown in Figure 5.

4.3 Economic Values

According to the U.S. Bureau of Labor Statistics [51], the historical prices of lettuce over a period of 5 years was studied and the revenue in \$/Ha of lettuce grown in different configurations of monoculture and agrivoltaic farms are shown in Table 5. A sensitivity analysis of the lettuce prices over the last 10 years is also shown in Figure 6. From Figure 6 it is observed that over a 10 year period, the price of lettuce varies by less than 20% from an average price of \$2.23/kg. This variance thus does not significantly adversely affect the annual revenue from lettuce yields. The lack of trend in lettuce prices provides some stability for making revenue predictions in this context, although, it should be noted that the actual income for an individual farm to be 10% below the average as in 2008, would significantly impact a farmer. In addition, the value of the solar electricity generated from an agrivoltaic farm can vary widely, depending on the jurisdiction, incentives, value of carbon offsets among other factor. To obtain a benchmark value, the avoidable residential per unit cost of electricity is used, which in 2014 was \$0.125 on average in the U.S. [52]. Such a rate could be achieved in a power purchasing agreement with for example a utility or local microgrid. As can be seen in Table 6, farmers nearly produce the same value per hectare per year with a single season ground mounted agrivoltaic farm as they do in a full sun summer and spring of conventional farming. The reduction in effort needed to produce this value may be an attractive investment for some farmers if the capital costs of the PV systems are reduced far enough. However, a half density agrivoltaic stilt mounted array can earn a conventional farmer over \$17,000/Ha/year or about 8% more than with conventional farming. This offers the benefit of reduced effort and a potential return on the investment of the PV system. The full density agrivoltaic stilt mounted array provides the best value, however as can be seen in Table 6. There is a substantial - over 30% increase in value assuming the residential electric rates in the U.S.

However, a net-metered average U.S. residential rate for electricity may not be available for all locations. To account for the variable rate of electricity a sensitivity analysis is provided starting at \$0.05/kWhr and increasing by \$0.05/kWhr increments to \$0.25/kWhr. The low end of the sensitivity corresponds to the wholesale cost of base load power, which represents an extreme under valuation of solar [53-55], while the high end represents the maximum avoidable cost of electricity in the U.S. The results of the variability of the annual electric yield are shown in Figure 7, which shows the annual total value (\$/Ha) as a function of PV electric price. From Figure 7, it can be deduced that the relation between the annual revenue(\$/Ha) and the per unit price of electricity is more or less linear and is dependent on the kWh/Ha quantities which in turn is dependent on how densely the PV arrays are spaced in a particular area. Hence, it can be concluded that the electricity revenue is dependent on the row spacing and the number of PV modules in a particular area. As the objective of an agrivoltaic farm is to grow crops and produce electricity, the right balance must be struck such that that the PV arrays do

not affect food production and vice versa. It should be pointed out here that the value of the PV-generated electricity could be substantially higher when the full cost of externalities are accounted for from conventional sources, but is left for future work.

The initial capital costs of an agrivoltaic farm are highly variable based primarily on the variables that influence traditional PV system costs [56] such as: the relative maturity of the PV industry in a given location that determines the soft costs [57], capital costs of the PV modules and balance of system components that have been dropping substantially in all markets globally [58-60], access to financing mechanisms and the loan structures available [61-63], taxes and potential incentives [64]. These in turn along with the discount rate influence the levelized cost of electricity (LCOE) [65].

For an agrivoltaic farm to be financially viable the following relationship must be true:

$$V_{c(\text{trad})} < (V_c + S) \quad (2)$$

Where $V_{c(\text{trad})}$ is the traditional value of the crop without an agrivoltaic installation per hectare per year, V_c is the value of the crop with agrivoltaic losses per hectare per year, and S is the solar profit per hectare per year given by

$$S = V_e - V_{\text{LCOE}} \quad (3)$$

Where V_e is the value of the solar generated electricity per hectare per year and V_{LCOE} is the cost of the electricity, which is given by:

$$V_{\text{LCOE}} = \text{LCOE} \times E_{\text{av}} \quad (4)$$

Where LCOE is the levelized cost of electricity (\$/kWh) and E_{av} is the solar electricity generated per hectare per year on the agrivoltaic farm.

Returning to the case study and utilizing the values from Table 5 in the full density case the full density profit potential of the solar electricity S must be \$63,138 or more and for the half density case it must be \$17,706 or more. If the full density is 720 kW and the half density is 390 kW the value of the capital cost break-even points can be seen in Figure 8. The assumptions to construct Figure 8 are detailed in Branker et al.'s review of LCOE methodology [65] and include a discount rate of 4.5%, loan term of 30 years, degradation rate of 0.5%/year, insurance cost of 1.5%, O&M costs of 9%, and a zero interest loan of 100% debt. As can be seen in Figure 8, the solar profit reduces for full density (8A), ground mount (8B) and half density (8C) as the installed costs increases. The values of the installed costs that result in profitably in this scenario can be read off of the 3-D graphs. These results are for standard issue PV systems found in most PV farms and thus are already optimized for price and require low maintenance.

5. Discussion and Future Work

The agrivoltaic system investigated in this study is designed to accommodate modern farming equipment which spread dust causing soiling of the PV modules and affecting the power output as dust diminishes the transmittance of the transparent collectors on the PV module surface [49]. This would require cleaning of the PV modules at periodic intervals in relation to the agricultural activity to maintain optimum electricity output. This could be done either as part of the maintenance schedule of the standard farming routine or be accomplished through the use of irrigation spraying. The PV arrays can act as a rainwater and irrigation runoff channel, which can drain the rainwater directly on the crops, depending upon the system geometry. When used in conjunction with a sprinkle irrigation system, the water sprinkled on the PV arrays would clean the PV arrays and drain off on the crops, thus facilitating effective water usage. This scheme would prove effective in a country like India that has a distinct

monsoon climate where annual rainfall is concentrated mainly between June to September followed by a dry period throughout the year. In excessively dusty atmospheres, PV modules with self-cleaning glass surface [66] can be used as a solution to keep the PV modules clean at all times without the need of frequent cleaning. Further work in this area is needed to determine both the technical and economic viability of such an approach.

More advanced PV systems could be designed to further reduce the impact on agricultural yields of agrivoltaic systems. For example, the tilt angle of the PV modules can be varied using an automated systems such that the shading is at a minimum during the germination stage to prevent growth inhibition of the crops and the PV modules can then be tilted back to its optimal tilt angle. This would increase both the crop yield and the electric yield. In general seasonal tilt adjustments are not made on large scale PV systems that are not dual axis trackers for economic reasons, but the economics may shift in an appropriately spaced agrivoltaic system. Partial shading offered by the PV arrays can help protect temperature sensitive crops from excessive heat. To strike the right balance between the PV power output and crop growth, simulations such as those performed in this study are needed to determine the optimal density of PV modules is based on the tilt angle, row spacing, agrivoltaic farm area and morphological traits of the crops with respect to shade tolerance. Significant future work is needed to find the optimal for yield for both lettuce investigated here, but also other shade resistant crops.

Many crops have not been evaluated for agrivoltaic applications. Future work is needed in the field of agrivoltaic systems to extend its implementation to shade tolerant greens other than lettuce including: arugula, Asian greens, chard, collard greens, kale, mustard greens, parsley, sorrel, spinach, and scallions [67-68]. In addition, other brassicas such as broccoli, kohlrabi, and cabbage will also grow in partial shade [67-68] and other crops such as hog peanut, alfalfa [36] yam, taro, cassava and sweet potato [37] should be investigated for agrivoltaic applications after studying the morphological traits of such crops to understand their behavior and light requirement patterns during different stages of their life from germination to harvest. The shade tolerance depends on the radiation interception efficiency (RIE) of the leaves and is independent of the level of shading. Hence, when lettuce is grown under shading, it compensates for the constant RIE by increasing its leaf area to maximize its ability to tap the most of the incoming solar radiation [30]. There is currently a large dearth of information on the shade tolerance of crops and those with data are not overly promising. For example, maize grown under shade experiences a reduction in stem height, leaf area, and photosynthesis rate [69]. This may be a useful application of citizen science [70].

The bench-mark economic values in this study only cover the revenue per hectare per year for agrivoltaic farms. The highest value of earnings per year comes from a conventional optimized solar farm (values from Figure 4) and the per unit cost of electricity yields, \$274,000/Ha/year. Converting agricultural farms into solar farms, however, has notable drawbacks as discussed in the introduction such as increased food prices and the concomitant hunger related diseases. Therefore, the approach investigated here provides for an increase in farm revenue per unit area while only reducing agricultural output on the farm modestly (12%, 34% and 36% reduction for half, full density, and ground mounted, respectively). To arrive at an economic optimum a full life cycle analysis would need to be done on the agrivoltaic systems comparing the value output to the levelized cost of the systems over their life cycle. This analysis would include sensitivities on variables such as the escalation rates in food, energy prices and farm input costs as well as financing as they can all be variable.

Even without a full life cycle analysis the results from this study indicate that agrivoltaic farms

could be profitable for conventional farmers and as population and energy use continue to rise more efficient use of land will become necessary. It is instructive to calculate the power potential of the current agricultural land if converted to an agrivoltaic farm. As of 2012, the total area under lettuce cultivation in the USA was 267,100 acres (108,000 Ha) [71]. Considering only the lettuce cultivation area of the U.S. the solar power potential is substantial as shown in Table 6.

Both the Half Density and Ground Mounted arrays could support over 40GW of PV using the area currently used for lettuce production, while the full density arrays could support over 77 GW of additional PV capacity. To put this number in perspective the Solar Energy Industries Association expects the entire U.S. PV installed capacity to only reach 40GW in 2017 [72].

6. Conclusions

The agrivoltaic system is a solution to the intense competition for the land resources between food and energy production. Several experiments were summarized here that show an immense potential of agrivoltaic systems if implemented with many shade-tolerant crops. The results here found that using residential electric rates in the U.S. as the value of solar generated electricity created over 30% increase in value from farms deploying agrivoltaic systems over conventional agriculture. If shade tolerant crops are utilized, crop yield losses are minimized. This dual use of agricultural land can have a significant effect on national PV production, with minimal impact on food prices. For example, the results here showed an increase in PV power between over 40 and 70GW if lettuce cultivation alone is converted to agrivoltaic systems in the U.S., which is more than the entire domestic production at the time of this writing. It is clear, further work is needed in this area and that the outputs for different crops and geographic areas should be explored to ascertain the potential of agrivoltaic farming throughout the globe.

References

- [1] Droege P, Renewable Energy and the City: Urban Life in an Age of Fossil Fuel Depletion and Climate Change, *Bulletin of Science, Technology & Society* 2002;22(2),87–99.
- [2] Moss RH, Edmonds JA, Hibbard KA, Manning MR, Rose SK, van Vuuren DP. The next generation of scenarios for climate change research and assessment . *Nature*, 2010;463(7282), 747–756.
- [3] Stern Review- The Economics of Climate Change. Available at<http://webarchive.nationalarchives.gov.uk/+http://www.hm-treasury.gov.uk/media/4/3/executive_summary.pdf> (accessed on October 18, 2014)
- [4] Flavin C, Slowing Global Warming, *Environmental Science & Technology*. 1990;24(2), 170-171.
- [5] Steinberg M, Fossil Fuel Decarbonization Technology for Mitigating Global Warming, *International Journal of Hydrogen Energy* 24, no. 8; 1999, pp.771–77.

[6] El-Fadel M, Chedid R, Zeinati M, Hmaidan W. Mitigating energy-related GHG emissions through renewable energy . *Renewable Energy*, 2003;28(8), 1257–1276.

[7]. Sims REH. Renewable energy: a response to climate change. *Solar Energy*, 2004;76(1-3), 9–17.

[8] Longo A, Markandya A, Petrucci M. The internalization of externalities in the production of electricity: Willingness to pay for the attributes of a policy for renewable energy. *Ecological Economics*, 2008;67(1), 140–152.

[9] Tsoutsos T, Papadopoulou E, Katsiri A, Papadopoulos AM. Supporting schemes for renewable energy sources and their impact on reducing the emissions of greenhouse gases in Greece. *Renewable and Sustainable Energy Reviews*, 2008;12(7), 1767–1788.

[10]. Granovskii M, Dincer I, Rosen M. Greenhouse gas emissions reduction by use of wind and solar energies for hydrogen and electricity production: Economic factors. *International Journal of Hydrogen Energy*, 2007;32(8), 927–931.

[11] Pearce JM, Photovoltaics - A Path to Sustainable Futures , *Futures*, 2002;34(7), 663-674.

[12] Barker PP, Bing JM. Advances in Solar Photovoltaic Technology: An Applications Perspective , *IEEE Power Engineering Society General Meeting*, 2005;2, 1955–60.

[13]IEA. Technology Roadmap: Solar Photovoltaic Energy, 2014.

[14] Alsema EA, Nieuwlaar E, Energy Viability of Photovoltaic Systems, *Energy Policy*, The viability

of solar photovoltaics, 2000;28(14), 999–1010.

[15] Wiginton LK, Nguyen HT, Pearce JM. Quantifying rooftop solar photovoltaic potential for regional renewable energy policy , *Computers, Environment and Urban Systems* 2010;34, 345-357.

[16] Nguyen HT, Pearce JM, Harrap R, Barber G, The Application of LiDAR to Assessment of Rooftop Solar Photovoltaic Deployment Potential on a Municipal District Unit , *Sensors*. 2012;12, 4534-4558.

[17] Nguyen HT, Pearce JM. Automated Quantification of Solar Photovoltaic Potential in Cities *International Review for Spatial Planning and Sustainable Development*. 2013;1(1), 57-70.

[18] de Wild-Scholten MJ, Alasema EA, ter Horst EW, Bachler M, Fthenakis VM. A Cost and Environmental Impact Comparison of Grid-Connected of Rooftop and Ground Based PV Systems, 21st European Solar Photovoltaic Energy Conference. 2006.

[19] Nguyen HT, Pearce JM. Estimating Potential Photovoltaic Yield with r.sun and the Open Source Geographical Resources Analysis Support System *Solar Energy*. 2010;84, 831-843.

[20] Bolinger M. *Utility-Scale Solar 2012: An Empirical Analysis of Project Cost, Performance, and Pricing Trends in the United States*. 2012.

[21] Fairley P. Big solar's big surge, *Spectrum, IEEE*, 2015;52(1), 41-44.

[22] Nonhebel S. Renewable Energy and Food Supply: Will There Be Enough Land?, *Renewable and Sustainable Energy Reviews*. 2005; 9(2) 191–201.

[23] Calvert K, Pearce JM, Mabee WE. Toward renewable energy geo-information infrastructures: Applications of GIScience and remote sensing that can build institutional capacity *Renewable and Sustainable Energy Reviews*. 2013; 18, 416–429.

[24] Calvert K, Mabee W. More Solar Farms or More Bioenergy Crops? Mapping and Assessing Potential Land-Use Conflicts among Renewable Energy Technologies in Eastern Ontario, Canada, *Applied Geography*. 2015;56,209–21.

[25] United Nations Dept. of Economic and Social Affairs, 2014 at <http://www.un.org/en/development/desa/population/publications/pdf/trends/Concise%20Report%20on%20the%20World%20Population%20Situation%202014/en.pdf> >(accessed on April 10, 2015)>.

[26] Talbot G. L'intégration spatiale et temporelle du partage des ressources dans un système agroforestier noyers-céréales : une clef pour en comprendre la productivité ? (phdthesis, Université Montpellier II - Sciences et Techniques du Languedoc). 2011.

[27] Kuemmel B, Langer V, Magid J, De Neergaard A, Porter JR. Energetic, Economic and Ecological

Balances of a Combined Food and Energy System, *Biomass and Bioenergy*. 1998; 15(4,5), 407-16.

[28] Goetzberger A, Zastrow A. On the Coexistence of Solar-Energy Conversion and Plant Cultivation, *International Journal of Solar Energy* 1, no. 1. 1982; p .55–69.

[29] Marrou H, Wery J, Dufour L, Dupraz C. Productivity and Radiation Use Efficiency of Lettuces Grown in the Partial Shade of Photovoltaic Panels, *European Journal of Agronomy*. 2013;44,54–66.

[30] Marrou H, Guilioni L, Dufour L, Dupraz C, Wery J. Microclimate under agrivoltaic systems: Is crop growth rate affected in the partial shade of solar panels?. *Agricultural and Forest Meteorology*, 2013;177, 117-132.

[31] Dupraz C, Marrou H, Talbot G, Dufour L, Nogier A, Ferard Y. Combining solar photovoltaic panels and food crops for optimising land use: Towards new agrivoltaic schemes. *Renewable Energy*, 2011;36(10), 2725-2732.

[32] Zhu XG, Long SP, Ort DR. What Is the Maximum Efficiency with Which Photosynthesis Can Convert Solar Energy into Biomass?, *Current Opinion in Biotechnology, Food biotechnology / Plant biotechnology*, 2008;19(2),153–59.

[33] Dupraz C, Talbot G, Marrou H, Wery J, Roux S, Liagre F, Ferard Y, Nogier A. To mix or not to mix: evidences for the unexpected high productivity of new complex agrivoltaic and agroforestry systems. Conference: Resilient Food Systems for a changing world : 5th World Congress of Conservation Agriculture:Resilient Food Systems for a changing world.[http://aciar.gov.au/files/node/13992/to mix or not to mix evidences for the unexpected 19701.pdf](http://aciar.gov.au/files/node/13992/to_mix_or_not_to_mix_evidences_for_the_unexpected_19701.pdf). 2011.

[34] Hallik L, Niinemets Ü, Wright IJ. Are Species Shade and Drought Tolerance Reflected in Leaf-Level Structural and Functional Differentiation in Northern Hemisphere Temperate Woody Flora?, *New Phytologist*. 2009; 184(1), 257–74.

[35] Li F, Meng P, Fu D, Wang B. Light Distribution, Photosynthetic Rate and Yield in a Paulownia-Wheat Intercropping System in China. *Agroforestry Systems*. 2008; 74(2), 163-172.

[36] Lin CH, McGraw RL, George MF, Garrett HE, Shade Effects on Forage Crops with Potential in Temperate Agroforestry Practices, *Agroforestry Systems*. 1998;44(2,3) 109–19.

[37] Johnston M, Onwueme IC. Effect of Shade of Photosynthetic Pigments in the Tropical Root Crops: Yam, Taro, Tannia, Cassava and Sweet Potato, *Experimental Agriculture* 1998;34(3),301–12.

[38] Mehleri ED, Zervas PL, Sarimveis H, Palyvos JA, Markatos NC, Determination of the Optimal Tilt Angle and Orientation for Solar Photovoltaic Arrays, *Renewable Energy*. 2010; 35(11),2468–75.

[39] Skoplaki E, Palyvos JA. Operating Temperature of Photovoltaic Modules: A Survey of Pertinent

Correlations, *Renewable Energy*. 2009;34(1),23–29.

[40] Talbot G, Roux S, Graves A, Dupraz C, Marrou H, Wery J. Relative Yield Decomposition: A Method for Understanding the Behaviour of Complex Crop Models, *Environmental Modelling & Software*, 2014;51, 136–48.

[41] Gronauer A. Energietechnik. Alternative Energien, http://digisrv-2.biblio.etc.tu-bs.de:8081/docportal/servlets/MCRFileNodeServlet/DocPortal_derivate_00033869/jahrbuchagrartechik2013_energietechnik.pdf. (accessed March 21, 2015).

[42] Scognamiglio A. Photovoltaic Greenhouses: A feasible solution for islands? Design, Operation, Monitoring and Lessons Learned from a Real Case Study. 2015.

[43] Cossu M, Murgia L, Ledda L, Deligios PA, Sirigu A, Chessa F. Solar Radiation Distribution inside a Greenhouse with South-Oriented Photovoltaic Roofs and Effects on Crop Productivity, *Applied Energy*, 2014;133,89–100.

[44] Wu Z, Hou A, Chang C, Huang X, Shi D, Wang Z. Environmental Impacts of Large-Scale CSP Plants in Northwestern China, *Environmental Science: Processes & Impacts*. 2014; 16(10),2432–41.

[45] Burney J, Woltering L, Burke M, Naylor R, Pasternak D. Solar-Powered Drip Irrigation Enhances Food Security in the Sudano–Sahel, *Proceedings of the National Academy of Sciences*, 2010;107(5), 1848–53.

[46] Marcheggiani E, Gulinck H, Galli A. Detection of Fast Landscape Changes: The Case of Solar Modules on Agricultural Land, *Computational Science and Its Applications – ICCSA 2013*, ed. Beniamino Murgante et al., *Lecture Notes in Computer Science* 7974. 2013;315–27.

[47] Wong PW, Shimoda Y, Nonaka M, Inoue M, Mizuno. Semi-Transparent PV: Thermal Performance, Power Generation, Daylight Modelling and Energy Saving Potential in a Residential Application, *Renewable Energy*. 2008;33(5),1024–36.

[48] Brisson N, Gary C, Justes E, Roche R, Mary B, Ripoche D. An Overview of the Crop Model STICS, *European Journal of Agronomy, Modelling Cropping Systems: Science, Software and Applications*. 2003;18(3,4), 309-332.

[49] Elminir HK, Ghitass AE, Hamid RH, El-Hussainy F, Beheary MM, Abdel-Moneim K. Effect of Dust on the Transparent Cover of Solar Collectors, *Energy Conversion and Management*. 2006; 47(18,19), 3192–3203.

[50] Marrou H, Dufour L, Wery J. How Does a Shelter of Solar Panels Influence Water Flows in a Soil–crop System?, *European Journal of Agronomy*. 2013; 50,38–51.

[51] US Bureau of Labor Statistics at <http://www.statista.com/statistics/236904/retail-price-of-lettuce-in-the-united-states/>(accessed on September 20, 2015).

- [52] US Energy Information Administration, 2015 at <http://www.eia.gov/forecasts/steo/report/electricity.cfm> (accessed on April 10, 2015).
- [53] Aznar, A.; Doris, E.; Nobler, E.; Truitt, S.; Hurlbut, D.; Bird, L.; Cory, K. Considerations for Value-of-Solar Methods. National Renewable Energy Laboratory. 2014.
- [54] Bird, L.; McLaren, J.; Heeter, J.; Linvill, C.; Shenot, J.; Sedano, R.; Migden-Ostrander, J. 2013. Regulatory Considerations Associated with the Expanded Adoptions of Distributed Solar. National Renewable Energy Laboratory.
- [55] Denholm, P.; Margolis, R.; Palmintier, B.; Barrows, C.; Ibanez, E.; Bird, L.; Zuboy, J. Methods for Analyzing the Benefits and Costs of Distributed Photovoltaic Generation to the U.S. Electric Utility System. 86 ; NREL Report No. TP-6A20-62447.
- [56] Denholm, P., Margolis R.M., Ong S., Roberts B.; Break-Even Cost for Residential Photo-voltaics in the United States: Key Drivers and Sensitivities, National Renewable Energy Laboratory (NREL) Technical Report. 2009; 1- 33.
- [57] Ardani, K., Barbose, G., Margolis, R., Wiser, R., Feldman, D., Ong, S. Benchmarking non-hardware balance of system (soft) costs for US photovoltaic systems using a data-driven analysis from PV installer survey results (No. DOE/GO-102012-3834). National Renewable Energy Laboratory (NREL), Golden, CO. 2012
- [58] Jogleka N.R., Graber-Lopez E.S., A Countdown towards Solar Power at Grid Parity: Policy Analysis Based on the Evolution of Price-Performance, Proc. 2008 ISDSI International Conf., 2008, 1-18.
- [59] Price S., Margolis R., 2008 Solar technologies market report, Energy Efficiency & Renewable Energy, US Department of Energy, January 2010, 1-131.
- [60] SEIA. 2015. Solar Industry Data. <http://www.seia.org/research-resources/solar-industry-data> (accessed on September 27, 2015).
- [61] Ameli, N., & Kammen, D. M. Innovations in financing that drive cost parity for long-term electricity sustainability: An assessment of Italy, Europe's fastest growing solar photovoltaic market. *Energy for Sustainable Development*, 2014, 19, 130-137.
- [62] Alafita, T., Pearce, J. M.. Securitization of residential solar photovoltaic assets: Costs, risks and uncertainty. *Energy Policy*, 2014, 67, 488-498.
- [63] Branker, K., Shackles, E., & Pearce, J. M. Peer-to-peer financing mechanisms to accelerate renewable energy deployment. *Journal of Sustainable Finance & Investment*. 2011, 1(2), 138-155.

Preprint of: Harshavardhan Dinesh, Joshua M. Pearce, The potential of agrivoltaic systems, *Renewable and Sustainable Energy Reviews*, 54, 299-308 (2016). DOI:[10.1016/j.rser.2015.10.024](https://doi.org/10.1016/j.rser.2015.10.024)

[64] Renewable Energy Policy Network for the 21st century (REN21), Renewables 2010 Global Status Report, Paris, 2010, 1-80.

[65] Branker, K., Pathak, M. J. M., Pearce, J. M. A review of solar photovoltaic levelized cost of electricity. *Renewable and Sustainable Energy Reviews*, 2011, 15(9), 4470-4482.

[66] Verma LK, Sakhuja M, Son J, Danner AJ, Yang H, Zeng HC. Self-Cleaning and Antireflective Packaging Glass for Solar Modules, *Renewable Energy*. 2011; 36(9),2489–93.

[67] Vanderlinden C. Best Shade-Tolerant Vegetables. Mother Earth news <<http://www.motherearthnews.com/organic-gardening/shade-tolerant-vegetables-zm0z11zsto.aspx>> (accessed March 21, 2015).

[68] Ahsan F. 2014 Top 12 shade tolerant vegetables and herbs for a shady garden <<http://theselfsufficientliving.com/shade-tolerant-vegetables-herbs/>> (accessed March 21, 2015).

[69] Fu J, Li CH, Zhao JR, Ma L, Liu TX. Shade-tolerance indices of maize: selection and evaluation., *Ying yong sheng tai xue bao = The journal of applied ecology / Zhongguo sheng tai xue xue hui, Zhongguo ke xue yuan Shenyang ying yong sheng tai yan jiu suo zhu ban*. 2011;20(11), 2705–2709.

[70] Conrad CC, Hilchey KG. A review of citizen science and community-based environmental monitoring: issues and opportunities. *Environmental monitoring and assessment*, 2011. 176(1-4), 273-291.

[71] Boriss H, Brunke H. <http://www.agmrc.org/commodities_products/vegetables/lettuce-profile/> (accessed on April 9, 2015)

[72] Kenning T. US solar installed capacity to reach 40GW by 2017. PV Tech. <http://www.pv-tech.org/news/us_solar_installed_capacity_to_reach_40gw_by_2017 > (accessed on June 1, 2015)

Figure Captions

Figure 1. Agrivoltaic farm schematic having ground mounted PV modules with the area between the panels being used for farming. The spacing between the panels has been kept wide enough to allow standard sized farming equipment to pass between the rows.

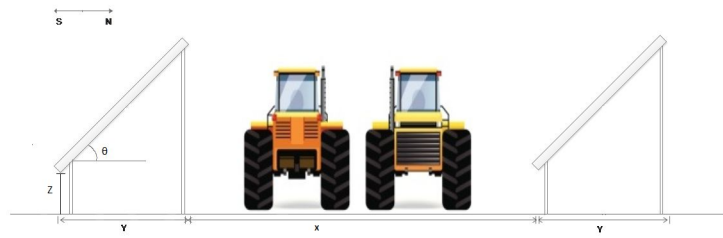

Figure 2. Agrivoltaic farm having PV modules mounted on stilts.

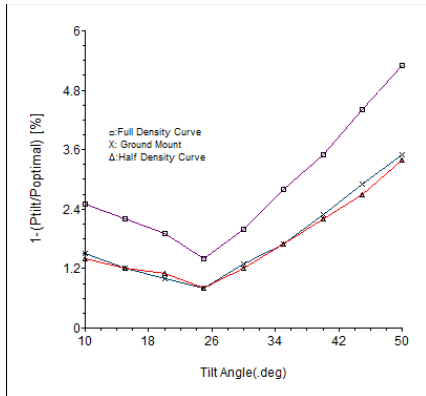
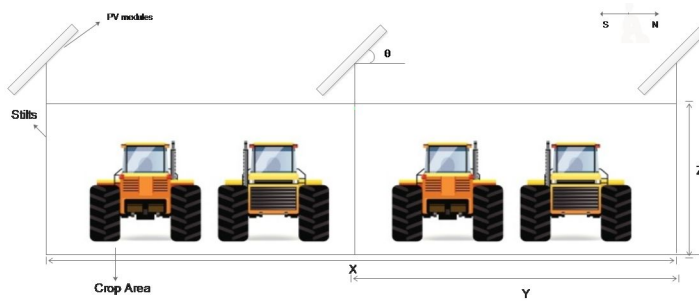

Figure 3. Relation between PV module tilt angle and loss of power output due to shading in selected agrivoltaic system designs.

Figure 4. Sensitivity graph of PV power output with respect to change in spacing.

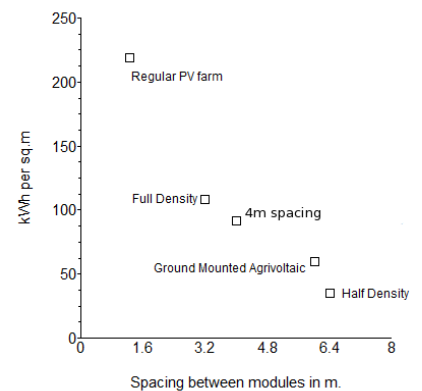

Figure 5. Sensitivity of lettuce plant weight with respect to change in shading values for agrivoltaic farm configurations.

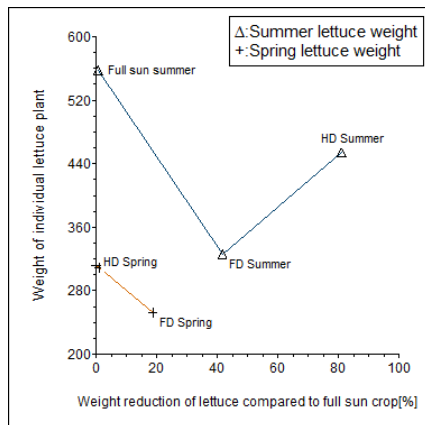

Figure 6. Sensitivity analysis of lettuce prices over a 10 year period.

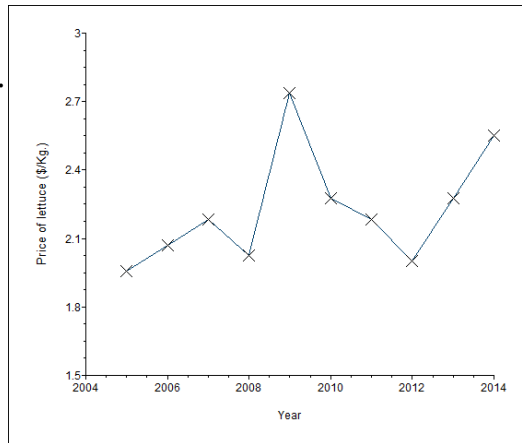

Figure 7. Electricity revenue with respect to change in the per unit cost of electricity for various agrivoltaic farm configurations.

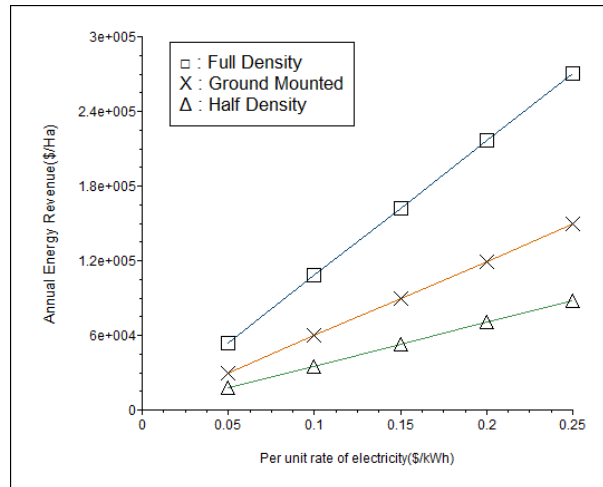
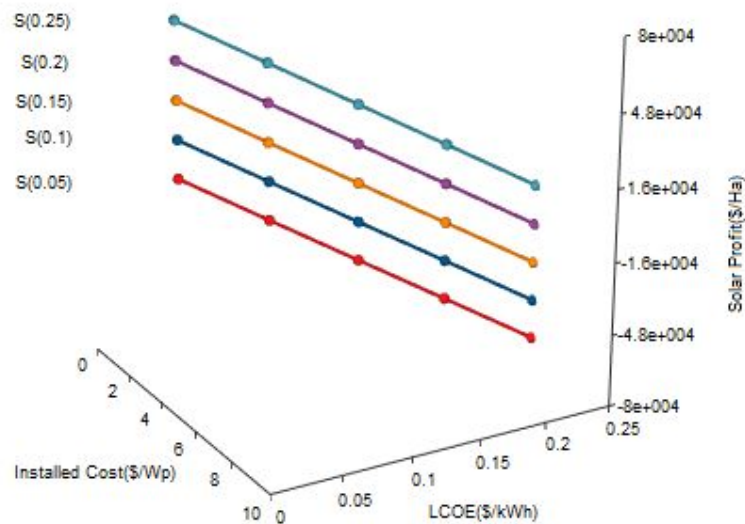
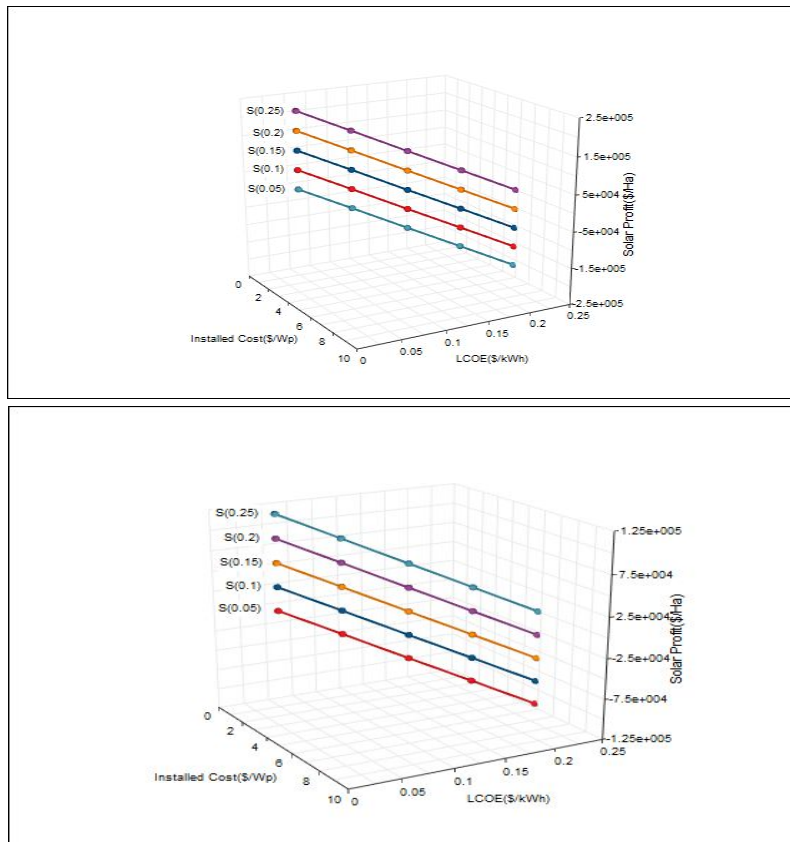

Figure 8. Effect of electricity cost and installed costs on the solar profit for full density (8A), ground mount (8B) and half density (8C), configurations respectively.



Tables

Table 1. Annual PV kWh output of a ground mounted agrivoltaic farm with row spacing of 6m.

Month	Horizontal Global Irradiation	Ambient Temp	Incident global irradiation	Effective global irradiation	Energy Output of PV Arrays	Energy injected into the arid	Efficiency of PV arrays	Efficiency of overall system
	kWh/m ²	°C	kWh/m ²	kWh/m ²	kWh	kWh	%	%
Jan	68.5	-1.8	105.3	101.4	1552	1482	14.89	14.23
Feb	83.3	2	113.4	109.2	1628	1555	14.52	13.86
Mar	121.3	5.8	146.7	141.4	2030	1939	13.98	13.35
Apr	152.6	13	163.5	157	2185	2089	13.5	12.91
May	183	18.4	182.2	174.7	2379	2275	13.19	12.61
Jun	193.7	22.6	187	179.1	2392	2287	12.93	12.36
Jul	203.1	25.7	200	191.7	2524	2415	12.75	12.2
Aug	178.6	24.9	187.1	179.6	2377	2277	12.84	12.29
Sep	138.2	20.4	160.3	154.4	2084	1994	13.14	12.57
Oct	109.4	13.8	145	139.9	1965	1880	13.7	13.1
Nov	69.8	7	102	98.2	1440	1375	14.27	13.62
Dec	58	0.6	90.4	86.8	1322	1261	14.78	14.1
Annual	1559.5	12.75	1782.8	1713.6	23878	22829	13.53	12.94

Table 2. kWh Output of a stilt mounted agrivoltaic farm mounted in FD configuration with row spacing of 3.2m.

Month	Horizontal Global Irradiation	Ambient Temp	Incident global irradiation	Effective global irradiation	Energy Output of PV Arrays	Energy injected into the arid	Efficiency of PV arrays	Efficiency of overall system
	kWh/m ²	°C	kWh/m ²	kWh/m ²	kWh	kWh	%	%
Jan	68.5	-1.8	105.3	101.1	1547	1478	14.85	14.19
Feb	83.3	2	113.4	108.9	1624	1550	14.47	13.82
Mar	121.3	5.8	146.7	141	2024	1934	13.94	13.32
Apr	152.6	13	163.5	156.4	2177	2081	13.46	12.86
May	183	18.4	182.2	174.1	2371	2267	13.15	12.57
Jun	193.7	22.6	187	178.5	2384	2280	12.89	12.32
Jul	203.1	25.7	200	191.1	2517	2408	12.72	12.17
Aug	178.6	24.9	187.1	179	2370	2270	12.8	12.26
Sep	138.2	20.4	160.3	153.9	2078	1988	13.1	12.53
Oct	109.4	13.8	145	139.6	1960	1875	13.66	13.07
Nov	69.8	7	102	97.9	1435	1370	14.22	13.58
Dec	58	0.6	90.4	86.4	1315	1254	14.7	14.03
Annual	1559.5	12.75	1782.8	1707.9	23802	22756	13.49	12.9

Table 3. kWh Output of a stilt mounted agrivoltaic farm mounted in HD configuration with row spacing of 6.4m.

Month	Horizontal Global Irradiation	Ambient Temp	Incident global irradiation	Effective global irradiation	Energy Output of PV Arrays	Energy injected into the arid	Efficiency of PV arrays	Efficiency of overall system
	kWh/m ²	°C	kWh/m ²	kWh/m ²	kWh	kWh	%	%
Jan	68.5	-1.8	105.3	101.6	915	872	14.93	14.23
Feb	83.3	2	113.4	109.5	962	918	14.58	13.91
Mar	121.3	5.8	146.7	141.8	1204	1150	14.1	13.46
Apr	152.6	13	163.5	157.5	1295	1237	13.6	13
May	183	18.4	182.2	175.3	1407	1345	13.26	12.68
Jun	193.7	22.6	187	179.7	1411	1350	12.97	12.4
Jul	203.1	25.7	200	192.4	1490	1426	12.79	12.25
Aug	178.6	24.9	187.1	180.2	1402	1344	12.87	12.33
Sep	138.2	20.4	160.3	154.8	1231	1178	13.19	12.62
Oct	109.4	13.8	145	140.3	1159	1109	13.73	13.14
Nov	69.8	7	102	98.5	849	809	14.3	13.62
Dec	58	0.6	90.4	87	779	741	14.81	14.08
Annual	1559.5	12.75	1782.8	1718.7	14103	13477	13.59	12.99

Table 4. Lettuce yields when grown in different configurations and seasons

Growing conditions	Season	Fresh Weight (g)	% Weight Reduction	Yield (tons/Ha)
Full Sun	Summer	561	N/A	50.49
	Spring	312	N/A	28.08
Ground	Summer	557	~0	50.13
Full Density	Summer	325	42	29.28
	Spring	246	21	22.18
Half Density	Summer	454	19	40.90
	Spring	309	1	27.80

Table 5. Annual \$/Hectare values for monoculture and agrivoltaic lettuce farms for lettuce alone and for PV.

Lettuce Growing Conditions	Yield(T/Ha)	Value(v_c) (\$/Ha)	Annual (v_c) (\$/Ha)	Annual (v_e) (\$/Ha)	Annual Total Value (\$/Ha)
Full Sun Summer	50.5	134,300	209,000	0	209,000
Full Sun Spring	28	74,700			
Ground Mounted Agrivoltaic Farm	50	133,000	133,000	74,612	207,612
Full Density Summer	29.3	77,900	136,900	135,238	272,138
Full Density Spring	22.2	59,000			
Half Density Summer	27.8	73,945	182,645	44,071	226,716
Half Density Spring	40.9	108,700			

Table 6: Maximum kW output per unit area from various configurations of agrivoltaic farms and estimation of GW available in U.S. if all lettuce cultivation was converted to agrivoltaic farms

Type of System	Modules/Ha	kW/Ha	GW Output(if applicable to US land area under lettuce cultivation)
Ground Mounted	1400	420	45
Full Density	2400	720	77
Half Density	1300	390	42